

GWS 0735

01
02

R1 C1

Glue area Fins

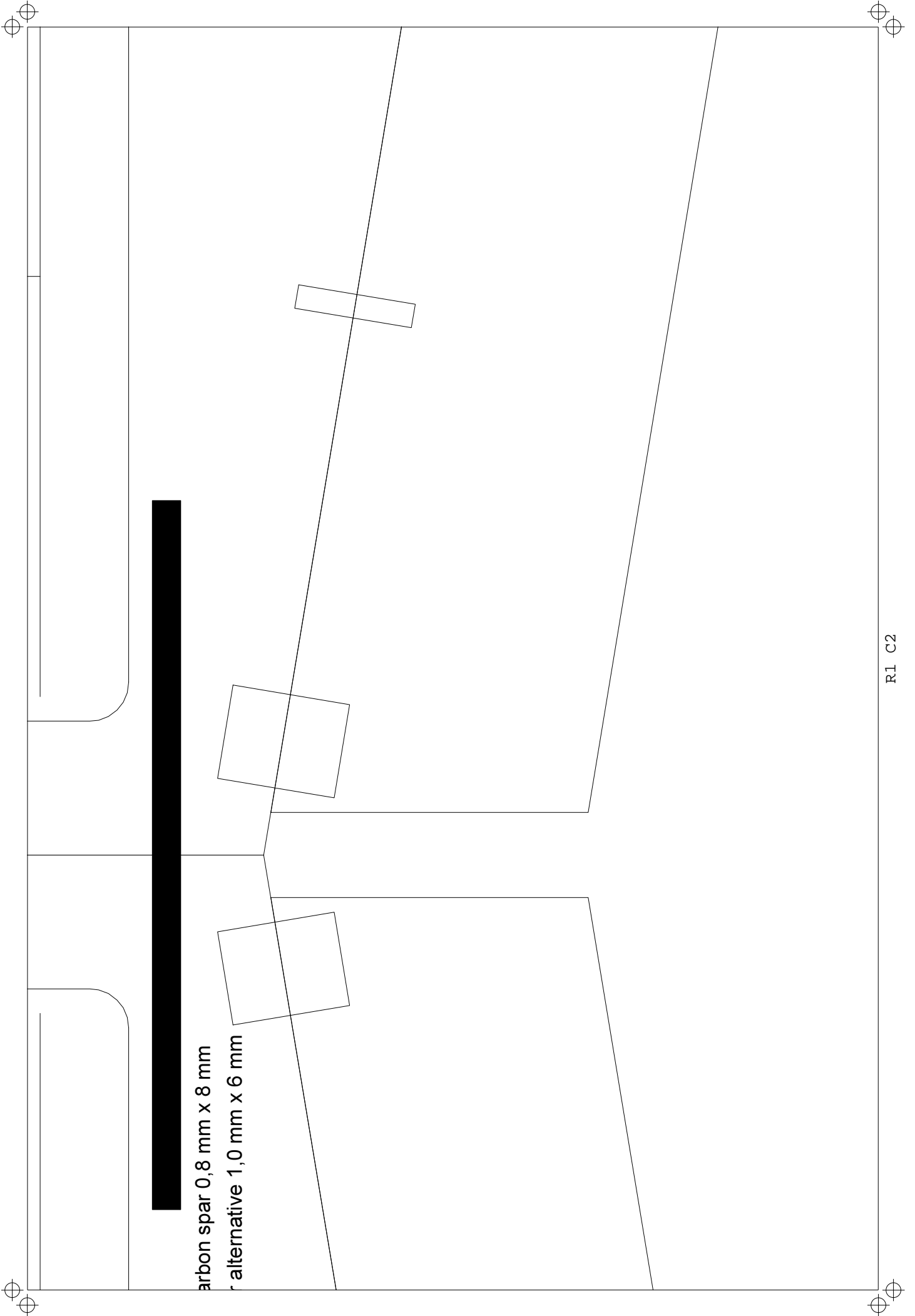

carbon spar 0,8 mm x 8 mm
alternative 1,0 mm x 6 mm

R1 C2

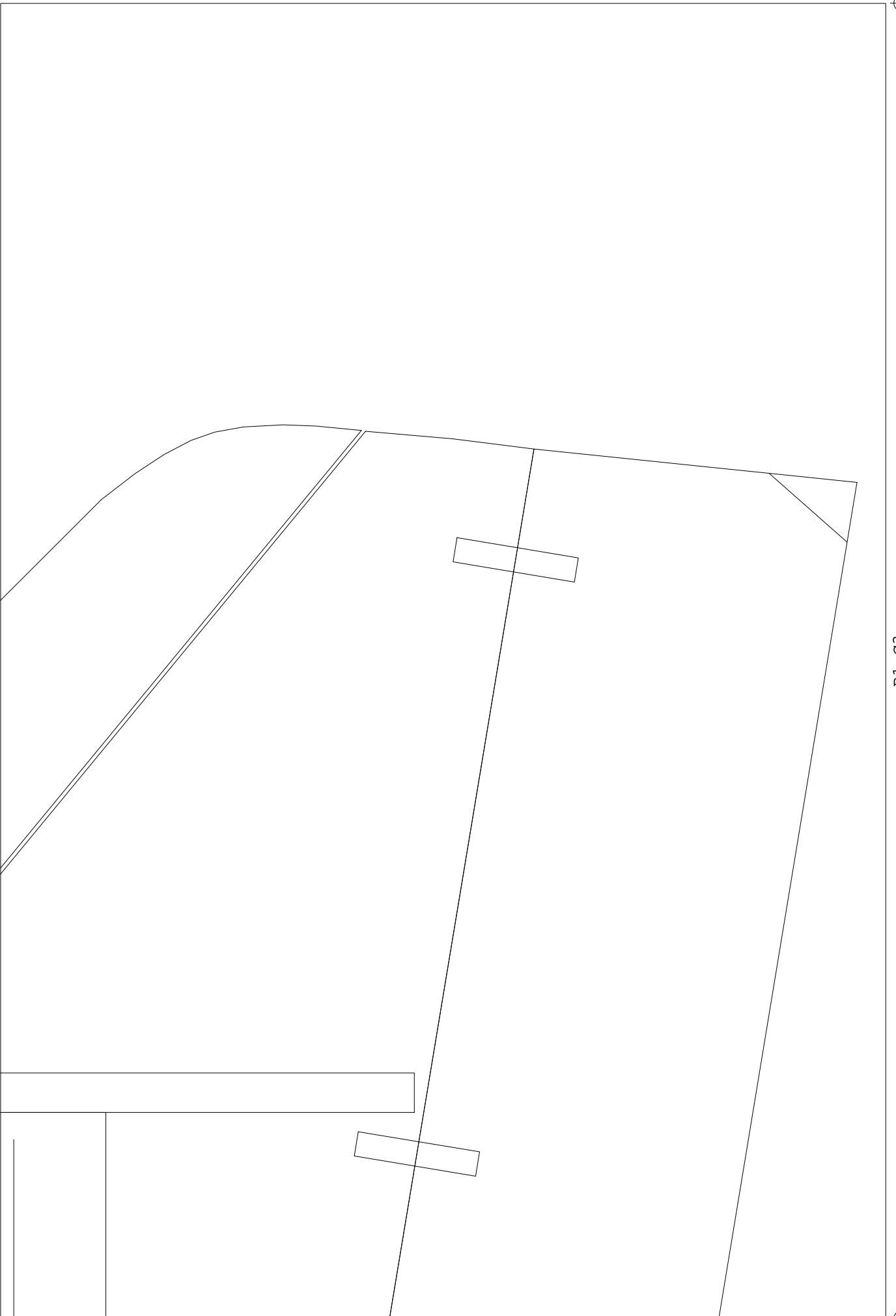

R1 C3



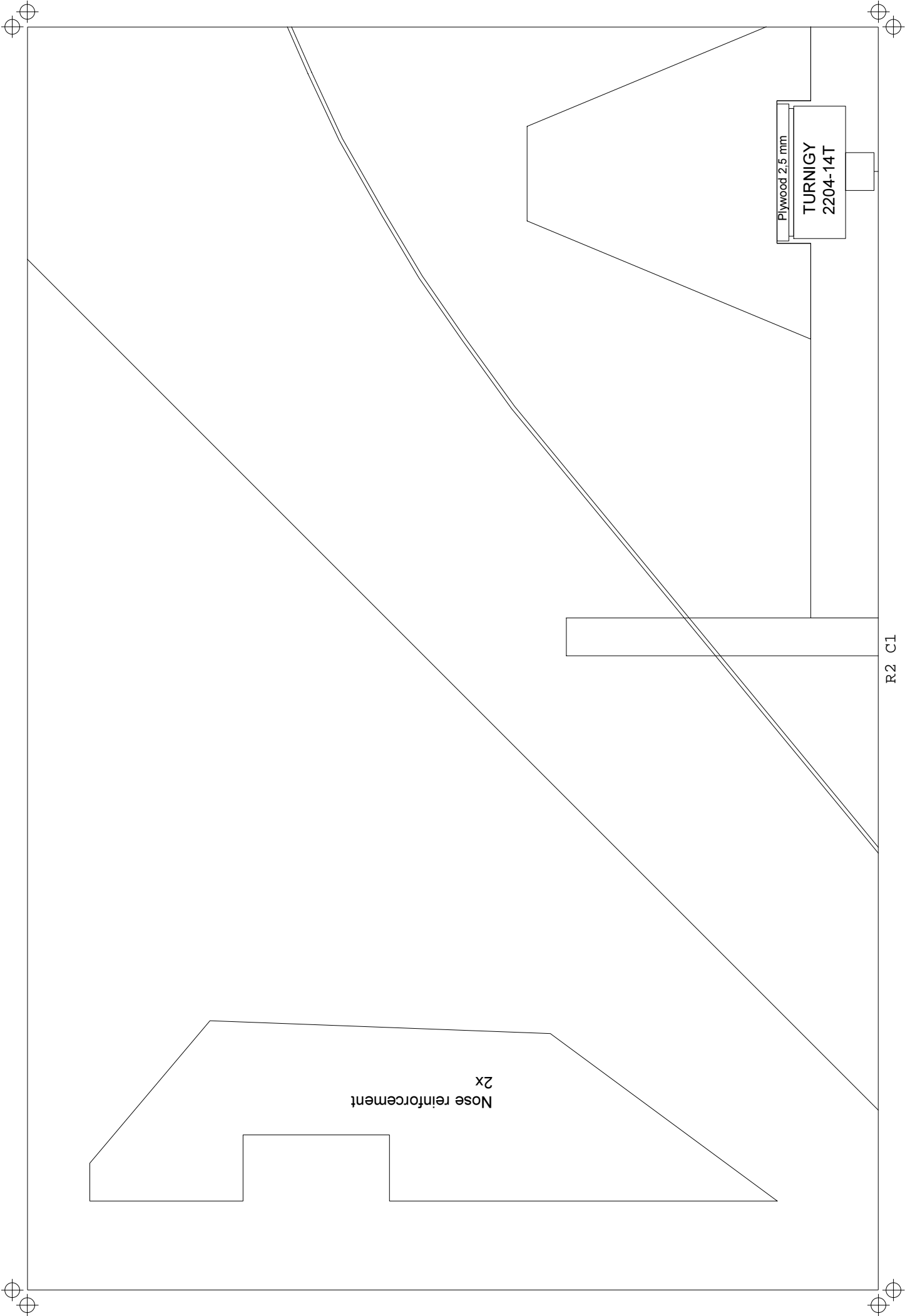

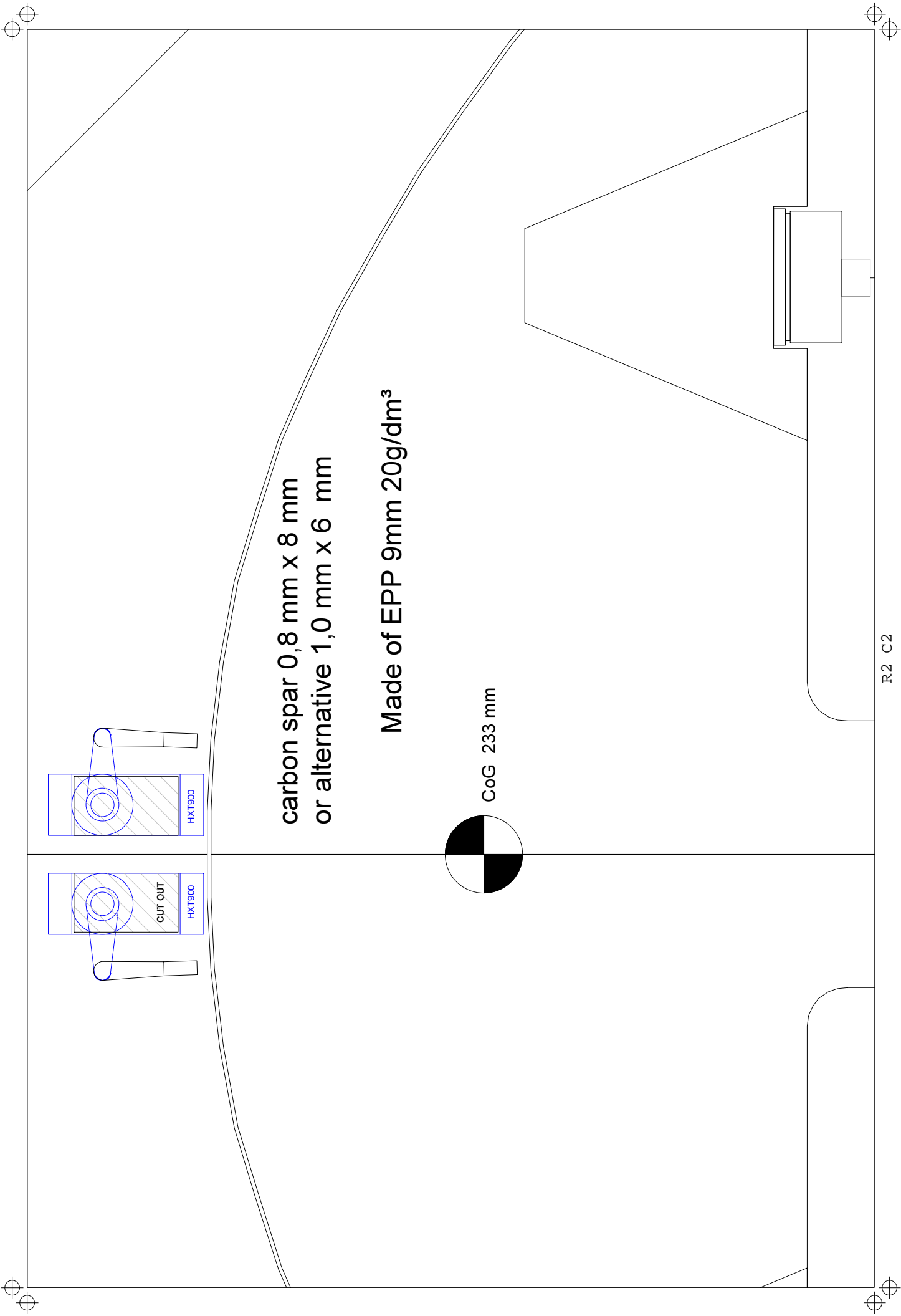

carbon spar 0,8 mm x 8 mm
or alternative 1,0 mm x 6 mm

Made of EPP 9mm 20g/dm³

CoG 233 mm

R2 C2

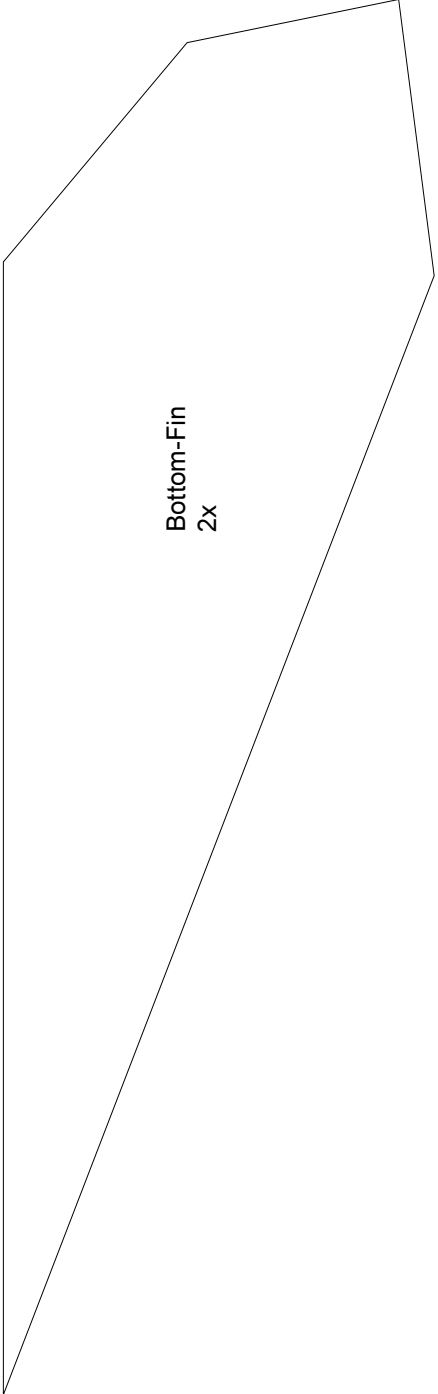

Bottom-Fin
2x

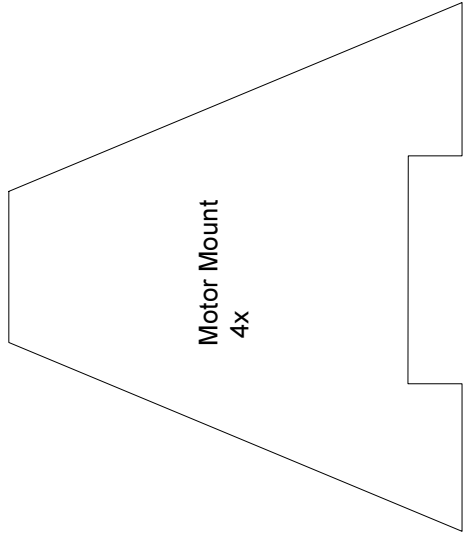

Motor Mount
4x



R2 C3



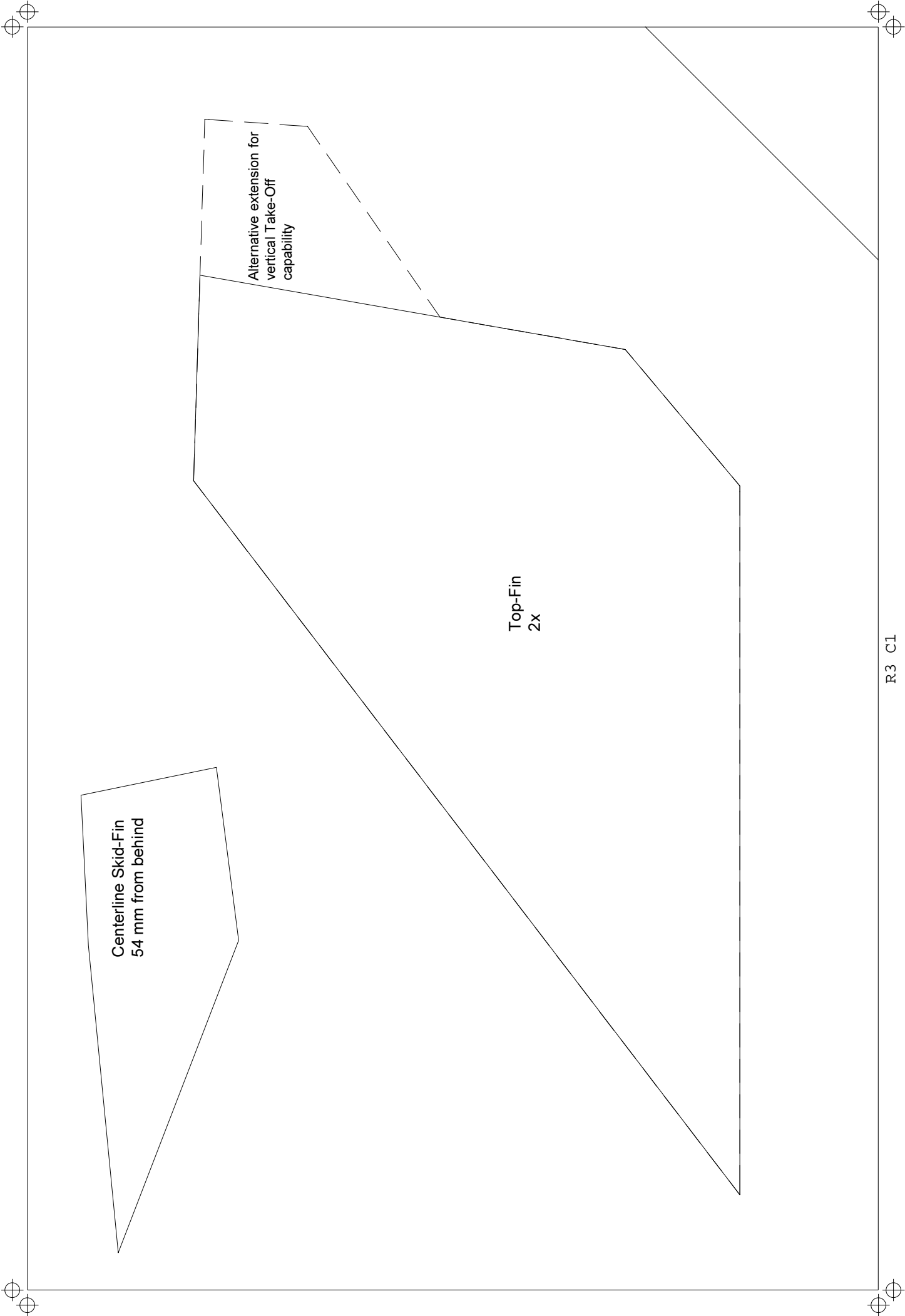

Centerline Skid-Fin
54 mm from behind

Alternative extension for
vertical Take-Off
capability

Top-Fin
2x

R3 C1

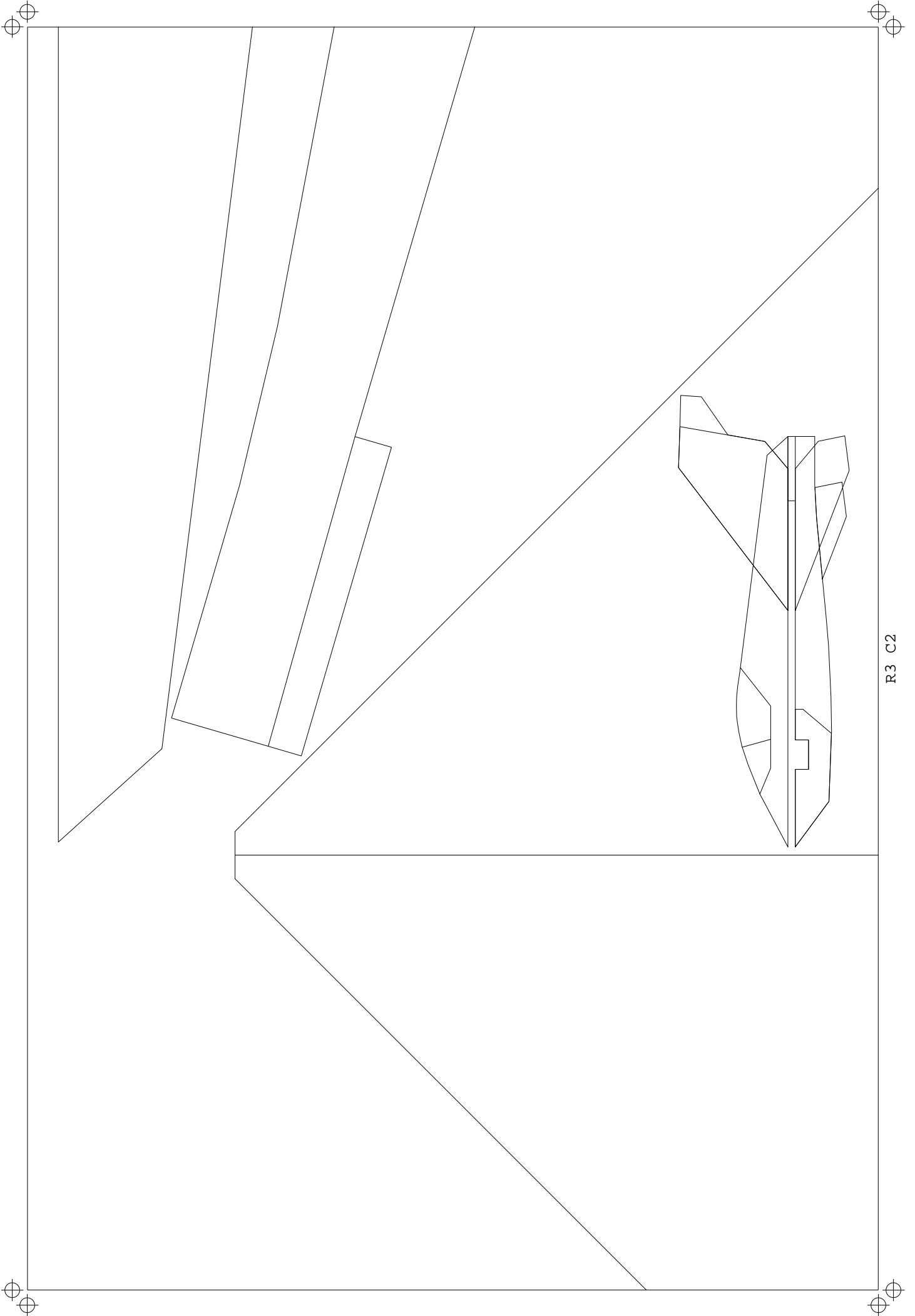

R3 C2

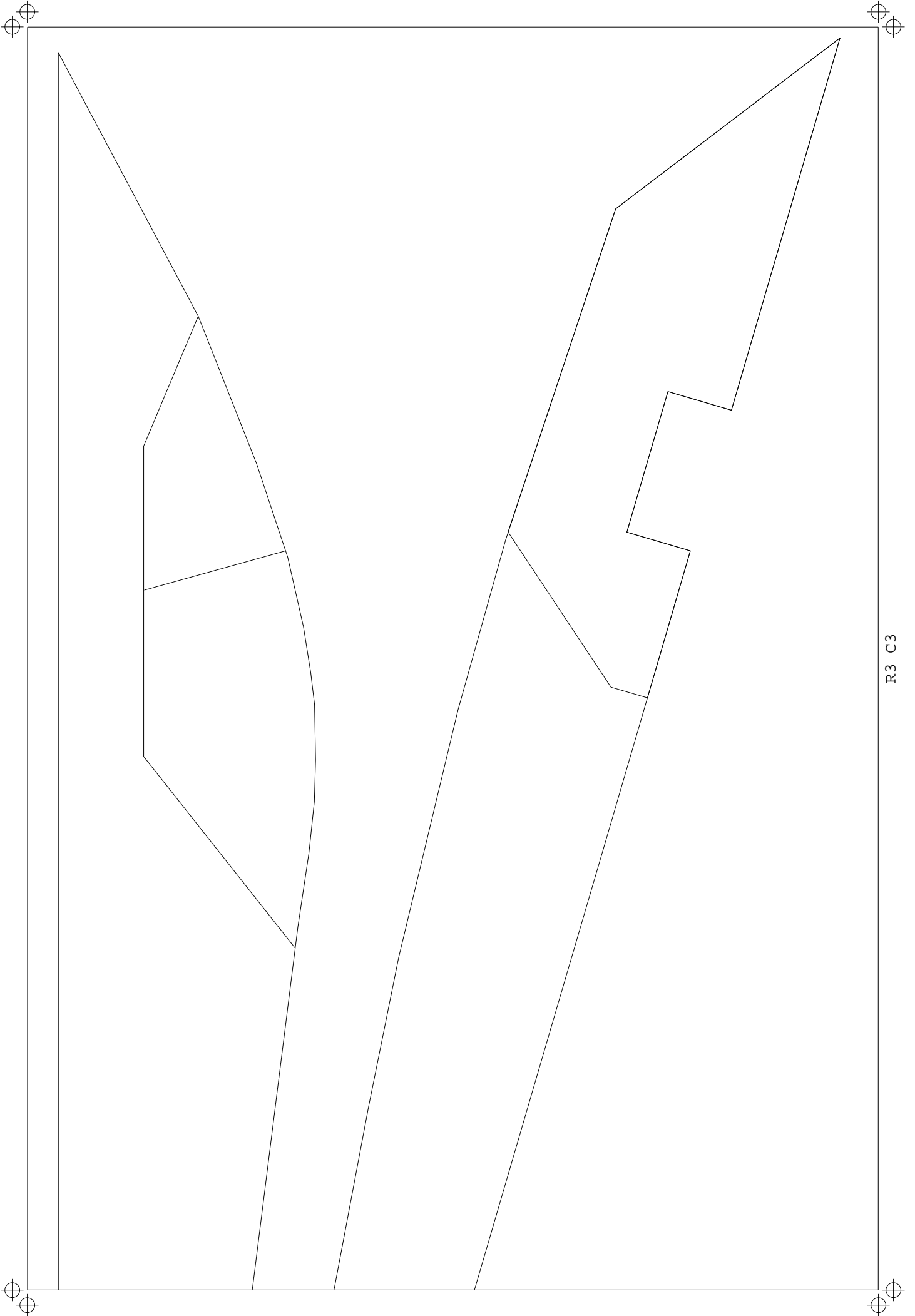

R3 C3